

KENWOOD

UNIVERSAL REMOTE CONTROL

RC-R0905

INSTRUCTION MANUAL

KENWOOD CORPORATION

About this remote control . . .

Compared to standard remote controls, this remote control has several operation modes. These modes enable the remote control to control other audio/video components. In order to effectively use the remote control, it is important to read the operating instructions and obtain a proper understanding of the remote control and how to switch its operation modes (etc.)

Using the remote control without completely understanding its design and how to switch the operation modes may result in incorrect operations.

2 Introduction

Thank you for purchasing the RC-R0905 universal remote control unit from KENWOOD.

This remote control unit is an optional unit designed for use with KENWOOD audio video receivers 1090VR and 1060VR.

For customers with the 1090VR, you can use this remote control specifically for ROOM B, allowing you to leave separate remote controls in each room. See the instruction manual supplied with your 1090VR for details.

For customers with the 1060VR, this remote control's FutureSet upgrade feature allows you to register and control components that could not be registered with the supplied remote control.

The input names and display information shown in this manual are those corresponding to the 1090VR audio video receiver. Likewise, the instructions regarding OSD operations are for 1090VR only. When using this remote control with the 1060VR, some of the input names and display information will be different. For details regarding the input names and display informations of the 1060VR, please refer to the instruction manual supplied with your receiver.

Precautions

Heat

- Avoid leaving the unit in direct sunlight or near a source of heat, such as a heater.

Water and moisture

- Avoid leaving the unit where it may be subject to high humidity.

Cleaning the unit

- When the unit becomes dirty, wipe it with a dry silicon cloth or a soft cloth. Do not use thinner, benzine, etc., as these could lead to discoloration.

Contents

Getting started	2
Introduction	2
Precautions	2
Special features	3
Names and functions of parts	4
Preparing the remote control	5
Operations	6
Registering setup codes for other components	6
Operating other components	8
Changing (confirming) the operation mode	9
Preparing for automatic operations (MACRO play)	10
Executing an automatic operation	12
Controlling the sound in another room (ROOM B) (for 1090VR)	13
FutureSet upgrade option	14
Setup code correlation	16
Set up code chart	17
In case of difficulty	23
Specifications	23
Remote operation of other components	24

Universal IR (InfraRed) remote control

In addition to the basic receiver operations, this remote control can also operate almost all of your remote controllable audio and video components. Just follow the simple setup procedure to register the components you have connected. → 6

Dual IR emitters

This remote control has two IR emitters: one to send commands in a straight line over long distances, allowing you to control the receiver and your other components from farther away; and one for wide dispersion of commands in a closer proximity, for near-field operation even when the remote control is not pointed directly at the respective component. → 5

MACRO play

The MACRO function lets you perform a series of operations automatically, like turning ON the power of the receiver and connected components, switching the input selectors, and starting playback. (Be sure to register your components before starting the macro set up procedure.) → 10

FutureSet, automatic update feature

This function lets you update the remote control so it can operate new components which do not appear in the setup code list at the end of the manual. Therefore, the remote control will always be compatible. → 14

For the U.S.A.

FCC WARNING

This equipment may generate or use radio frequency energy. Changes or modifications to this equipment may cause harmful interference unless the modifications are expressly approved in the instruction manual. The user could lose the authority to operate this equipment if an unauthorized change or modification is made.

NOTE:

This equipment has been tested and found to comply with the limits for a Class B digital device, pursuant to Part 15 of the FCC Rules. These limits are designed to provide reasonable protection against harmful interference in a residential installation. This equipment may cause harmful interference to radio communications, if it is not installed and used in accordance with the instructions. However, there is no guarantee that interference will not occur in a particular installation. If this equipment does cause harmful interference to radio or television reception, which can be determined by turning the equipment off and on, the user is encouraged to try to correct the interference by one or more of the following measures:

- Reorient or relocate the receiving antenna.
- Increase the separation between the equipment and receiver.
- Connect the equipment into an outlet on a circuit different from that to which the receiver is connected.
- Consult the dealer or an experienced radio/TV technician for help.

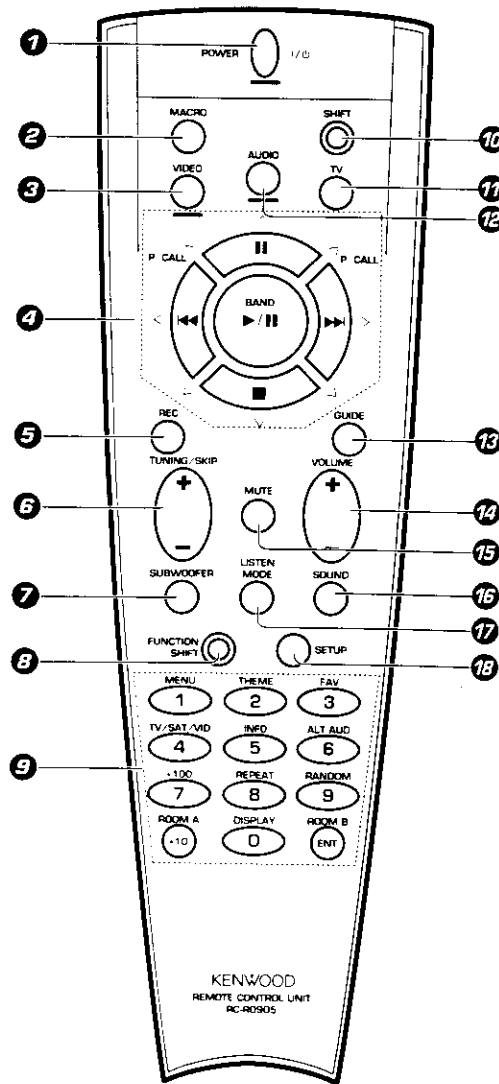

- 1 POWER key** — 6
Use to turn the receiver on and off.
Use in combination with the input selector (AUDIO, VIDEO, or TV) keys and SHIFT key to turn various components on and off.
- 2 MACRO key** — 10
Use in combination with the AUDIO, VIDEO, or TV keys to execute a series of commands automatically (MACRO PLAY).
- 3 VIDEO selector key** — 6
Selects the video inputs (VIDEO 1, VIDEO 2, VIDEO 3, VIDEO 4, AV/AUX) and sets the remote to operate the component registered at the respective input.
- 4 Multi control keys** — 24
Use to operate the selected component.
Use to operate the on-screen display (for 1090VR).
- 5 REC key** — 24
Use to operate the selected component.
- 6 TUNING/SKIP key** — 24
Use during the setup procedure to specify various settings. Use to operate the tuner or selected component.
- 7 SUBWOOFER key**
Use in combination with the VOLUME +/- keys to adjust the volume of the subwoofer.
- 8 FUNCTION SHIFT key** — 24
Use in combination with the numeric keys to execute alternate commands.

- 9 Numeric keys** — 24
Provide functions identical to those of the original remote supplied with the component you are controlling.
To access the functions printed above the keys, press within 3 seconds of pressing the FUNCTION SHIFT key. Function availability varies for each component.
- 10 SHIFT key** — 9
Use in combination with the AUDIO and VIDEO keys to change the remote control mode without changing the input selector or in combination with the POWER key to turn on and off components programmed into the remote.
- 11 TV selector key** — 6
Sets the remote to operate a TV or cable box (TV 1, TV 2, CABLE). This key does not change the input selector on the receiver.

- 12 AUDIO selector key** — 6
Selects the audio inputs (CD, TAPE1/MD, TUNER, PHONO) and sets the remote to operate the respective KENWOOD audio component.
If you connect audio components from KENWOOD and other makers to the TAPE1/MD or CD jacks, you can set the remote to operate these components by registering the appropriate setup code at the respective input.
- 13 GUIDE key** — 24
Use to activate the OSD menu functions of registered components.
- 14 VOLUME key**
Use to adjust the receiver volume.
- 15 MUTE key**
Use to temporarily mute the sound.
- 16 SOUND key**
Use to activate the Sound OSD and set the remote to OSD control mode (for 1090VR).
Use to adjust the bass, treble, and input level (for 1060VR).
- 17 LISTEN MODE key**
Use to select the desired surround mode.
- 18 SETUP key**
Use to activate the Setup OSD and set the remote to OSD control mode (for 1090VR).
Use to adjust the surround setup (for 1060VR).

Loading the batteries

① Remove the cover.

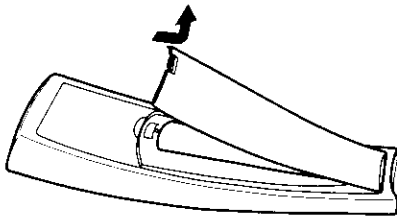

② Insert the batteries.

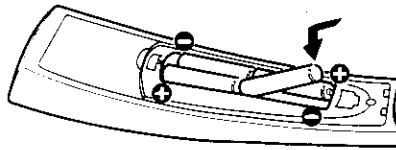

③ Close the cover.

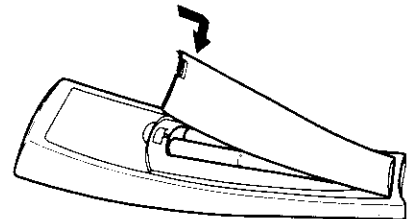

• Insert four AAA-size (LR03) batteries as indicated by the polarity markings.



1. Replace all four batteries with new ones when you notice a shortening of the distance from which the remote control will operate or if the remote control blinks 5 times when you push a key. The remote control is designed to retain set up codes in memory while you change batteries.
2. Placing the remote sensor in direct sunlight, or in direct light from a high frequency fluorescent lamp may cause a malfunction. In such a case, change the location of the system installation to prevent malfunction.

Operating distance

This remote control has two IR emitters: one to send commands in a straight line over long distances, allowing you to control the receiver and your other components from farther away; and one for wide dispersion of commands in a closer proximity, for near-field operation even when the remote control is not pointed directly at the respective component.

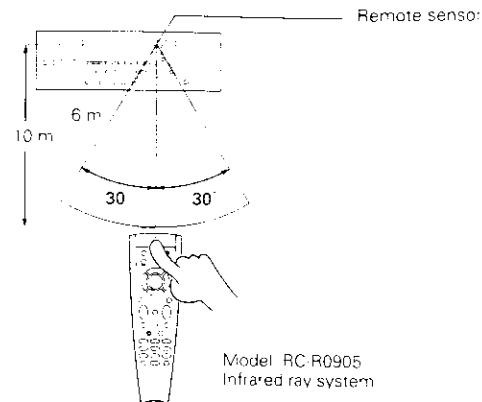

6 The remote control supplied with this receiver is also capable of controlling components from a variety of manufacturers once you register the appropriate setup codes into the remote control unit.
Refer to "Remote operation of other components" for details about the operations available for each component. — 24

* When registering setup codes for KENWOOD audio components which are connected to this unit by system control cords, use the following codes to insure proper system control operation: Cassette: 7000, CD: 8099, MD: 9000.
 To control other KENWOOD components (VCRs, LD players, audio components not connected with system control cords, etc.) follow the procedure described below.

Low battery warning

Replace all four batteries with new ones when you notice a shortening of the distance from which the remote control will operate or if the remote control blinks 5 times when you push a key. The remote control is designed to retain set up codes in memory while you change batteries.

Registering setup codes for other components

1 Find the setup code of the component to be registered.

- Refer to the setup code lists to find the setup code for the component to be registered. — 17
 Example: To register a CD made by KENWOOD, you would enter "8037"
- If you own a new component that is not covered by the setup code list, you can use the FutureSet upgrade feature. — 14

2 Hold down the ENT key until the backlight flashes twice and remains lit.

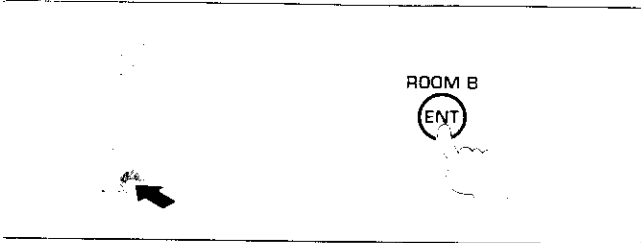

3 Select the component to be registered.

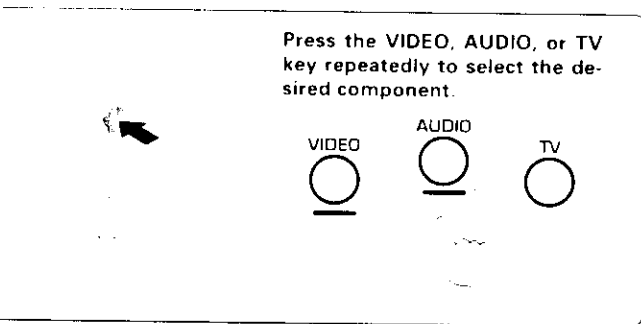

Input	Component	Maker	Code	Key
(CD)	CD player	KENWOOD	8026, 8037	AUDIO
VIDEO 1				
VIDEO 2				
VIDEO 3				
VIDEO 4				
TAPE1/MD				
CD				
PHONO				
—	TV 1			
—	TV 2			
—	CABLE			

• At this time all inputs become available regardless of any earlier registration.

Perform each of the following steps within 5 seconds.

VIDEO key

- 1 VIDEO1 (SAT)
- 2 VIDEO2 (LD)
- 3 VIDEO3 (VCR)
- 4 VIDEO4 (DSS)

AUDIO key

- 1 CD (CD)
- 2 TAPE1/MD (TAPE)
- 3 PHONO

TV key

- 1 TV1
- 2 TV2
- 3 CABLE

• Example : To register the component connected to the VIDEO 1 jacks, select "VIDEO 1 (SAT)".

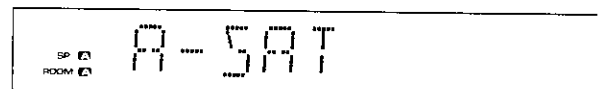

4 Enter the setup code.

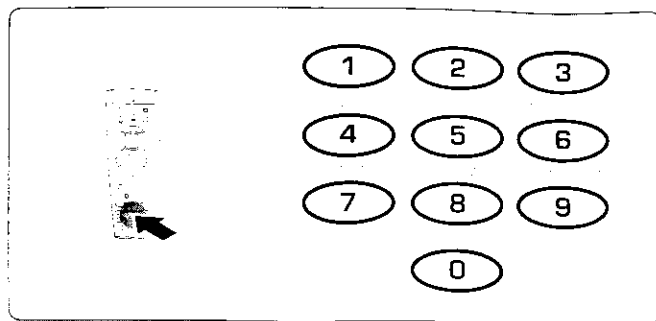

- Example: Press 5258 to register a LD player made by KENWOOD.
- The backlight flashes once each time a number is entered.
- If an invalid setup code is entered the remote will output one long blink; disregard that code and return to the beginning of step 4.
- If you push an invalid key, the remote will exit the setup mode.

5 Press POWER, and check to see that the component you want to control turns on.

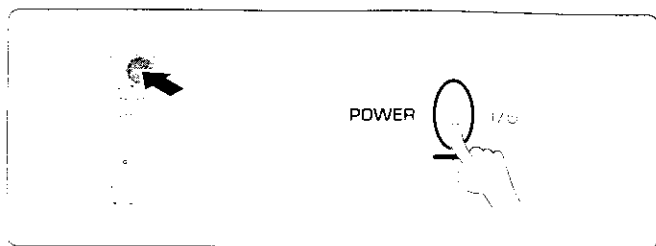

- **PLAY** or **TUNING/SKIP** (+/-) can also be used instead of **POWER**.
- If the component does not react, and there is more than one setup code, enter another setup code and try again.
- If the component is already on, pressing **POWER** will turn it off.

6 Press the ENT key to store the code you have just input.

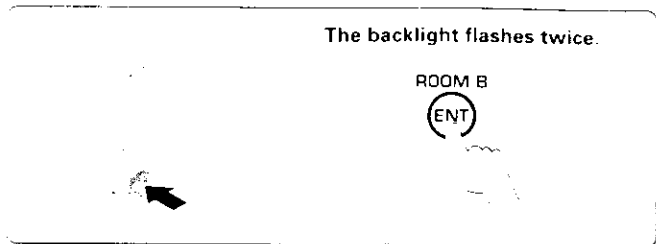

- This code replaces any previous setup codes entered for the respective component.

7 Repeat steps 3 to 6 for all components you want to control.

8 Hold down the ENT key until the backlight flashes twice.

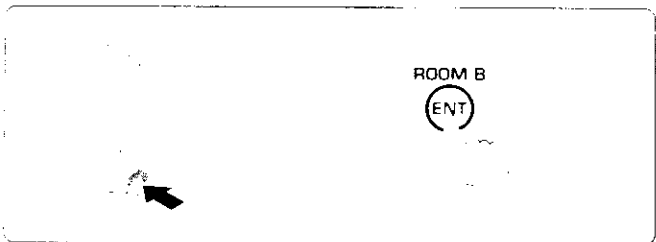

- If you have components that are not remote controllable, like a record player (etc.), you will need to register a Non-IR code at the respective input. This keeps the respective input in the remote control's cyclic list so you can select it using the remote control. Please consult the owner's manual of the components you are connecting for information regarding remote controllability. The list of Non-IR codes is included at the beginning of the Set up code chart.

- This operation should take about 3 seconds.
- Once registered, the display on the receiver shows the component type instead of the default input name.
Example: if you register a VCR at the VIDEO 1 jacks, "VCR" appears instead of "VIDEO 1(SAT)".
- Both the default input name and the component type (i.e., "VIDEO1 'VCR'") are shown in the on screen display when the OSD mode is set to ON (for 1090VR).
- After initial setup, any VIDEO (VIDEO 1, 2, 3, 4) or TV (TV1, TV2, CABLE) inputs that have not been programmed with a setup code or Non-IR code are deleted from the cyclic list (except for the "AV AUX" VIDEO input). The PHONO input will be deleted if a Non-IR code was not registered.
- The **INPUT SELECTOR** on the front panel of the receiver always cycles through all inputs.



Although each setup code is designed to work with a number of different models, certain codes may not work with some models. (Also, certain codes may only operate some of the functions available on a given model.)

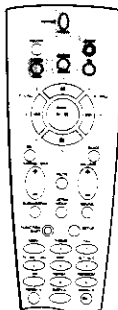

Keys or controls used in this operation

Operating other components

This operation lets you operate the registered components. KENWOOD audio components with system control turn on and off automatically with the receiver via the system control connections.

① Use the VIDEO, AUDIO, or TV keys to select the component you desire.

② Press the SHIFT key and then press the POWER key (within 3 seconds).

③ Press the operation keys you desire.

- Pressing the **VIDEO** or **AUDIO** key also changes the input selector on the receiver. If you do not want to change the current input, press the **SHIFT** key before step ①.

VIDEO key

- 1 VIDEO1 (VCR 1)
- 2 VIDEO2 (VCR 2)
- 3 VIDEO3 (LD)
- 4 VIDEO4 (DVD)
- 5 AV AUX

AUDIO key

- 1 CD (CD)
- 2 TAPE1/MD (TAPE)
- 3 TUNER
- 4 PHONO

TV key

- 1 TV1
- 2 TV2
- 3 CABLE

- Pressing the **SHIFT** key is only required when turning the selected component on or off. Pressing the **POWER** key directly turns the receiver on and off.

- See "Remote operation of other components" at the end of this manual for a list of keys available with each component.

The remote control mode remains in the set at the component selected in step ① mode until you select another component (etc.).



Be sure to point the remote control at the remote sensor on the receiver when you want to operate KENWOOD components connected by system control cards. Otherwise, point the remote control at the component you want to operate.

This operation lets you change the remote control operation mode without changing the input selector. You may find this useful when you want to control one component while using another. (For example, if you want to rewind the tape deck while listening to a CD.) This operation is also useful if you don't know the which mode the remote control is set to. Executing this operation allows you to change or reconfirm the operation mode you desire.

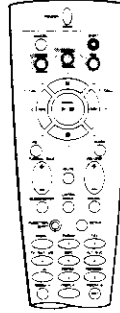

Keys or controls used in this operation.

Changing (confirming) the operation mode

1 Press SHIFT.

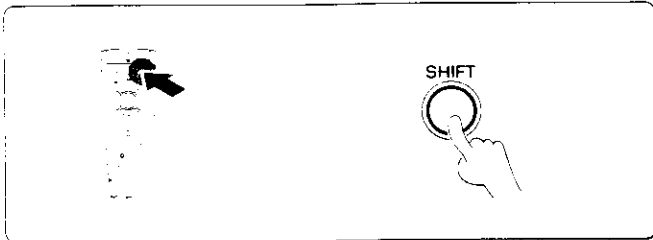

• To operate a TV, start from step 2.



Go to step 2 within 3 seconds.

2 Select the component to be controlled.

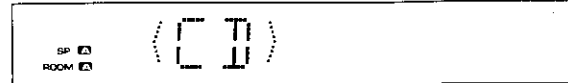
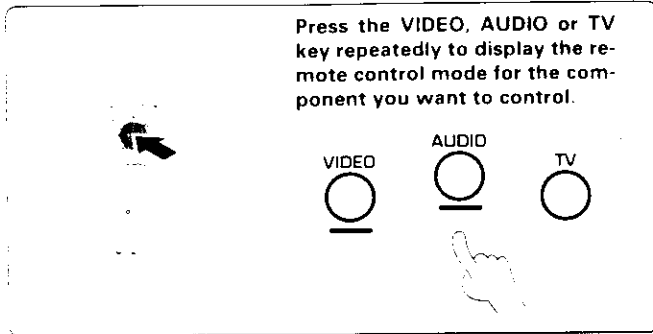

The component to be controlled is displayed in parenthesis

- Pressing any other keys after the **SHIFT** key cancels the shift function and sends the normal code associated with the respective key.
- The input selector does not change during this operation.
- The remote control mode is shown in the on screen display when the OSD mode is set to ON (for 1090VR).
- If you press **VIDEO** or **AUDIO** key more than 3 seconds after pressing the **SHIFT** key, the input selector changes together with the operation mode.

3 Execute the desired operations.

- See "Remote operation of other components" for a list of keys available with each component.

The operation mode remains set at the component specified in step 2.

To return control to the original component, press **SHIFT** and then press the **VIDEO** or **AUDIO** key to return to the original control mode.

10

The macro play function allows you to set the remote to control several components in succession. After completing this setup, you can perform a series of operations automatically. Enter the setup codes for the components you want to control beforehand.

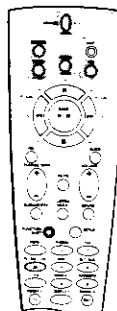

Keys or controls used in this operation.

Preparing for automatic operations (MACRO play)

1 Make a plan of the macro play you want to set up.

The order of the operations may be fairly complex and you may not be remember all of the necessary commands during the setup procedure.

Use the space provided below to write down the operations in the order you are going to enter them.

1			
2			
3			
4			
5			
6			
7			
8			
9			
10			

- Up to 20 steps can be memorized for each macro
- The example below shows the plan for step 4 (which occupies a total of 9 steps) :

1	TV + SHIFT + POWER	3 steps
2	FUNCTION SHIFT + 4	2 steps
3	VIDEO + VIDEO	2 steps
4	SHIFT + POWER	2 steps

Total 9 steps

- If you attempt to store more than 20 steps, the remote will output one long blink and exit the macro programming mode.
- Enter channel numbers (for the monitor TV, etc.) exactly as you would using the original remote.

2 Activate the macro program mode.

Press and hold the MACRO key until the backlight flashes twice.



MACRO



Perform each of the following steps within 5 seconds.

3 Select where the macro should be stored.

Press the VIDEO, AUDIO, or TV key to select the macro location. (MACRO1, 2, and 3 respectively)

- You can store up to 3 different macros, one at each key: VIDEO → "MACRO 1", AUDIO → "MACRO 2", TV → "MACRO 3"
- The backlight flashes once when you select the macro location.
- Pressing a button other than VIDEO, AUDIO, or TV cancels the macro program mode.

When VIDEO is pressed

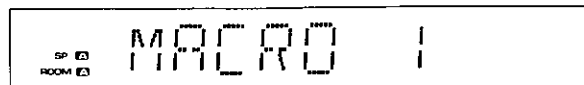

4 Press the keys to be operated in order.

EXAMPLE:

- 1 Press TV > SHIFT > POWER to turn on the TV.
- 2 Press FUNCTION SHIFT > "4" (TV/SAT./VIDEO) to set the TV to the appropriate video input.
- 3 Press VIDEO twice to select the LD player registered at VIDEO 2.
- 4 Press SHIFT and POWER to turn on the LD player.

- This example shows you how to create a macro that: turns on the TV, sets the TV to the appropriate input, selects the receiver's input selector to LD, and turns on the LD player. All you have to do is insert the laser disc!
- In order to allow verification of the remote control mode, the name of the selected input appears in the receiver's display when the VIDEO, AUDIO or TV key is pressed. When the VIDEO or AUDIO key is pressed the receiver's input also changes.

5 Terminate the macro program mode.

Press the MACRO key so that the backlight flashes twice.

- The macro is stored at the locations specified in step 3. If another macro was previously stored at the same location, it is erased.

Repeat steps 3 through 5 to program up to 3 macros.

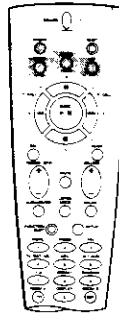

Keys or controls used in this operation.

Executing an automatic operation

1 Press the **MACRO** key.

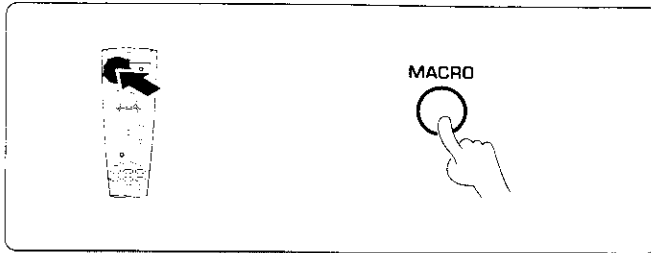

Go to step 2 within 3 seconds.

2 Execute the macro play.

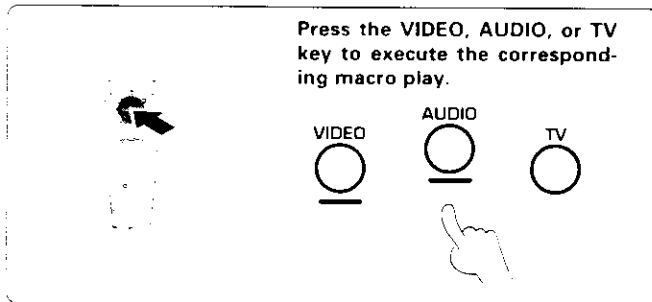

Press the **VIDEO**, **AUDIO**, or **TV** key to execute the corresponding macro play.

- "MACRO" appears in the front panel and on-screen display and the programmed macro is performed:
VIDEO → "MACRO 1", **AUDIO** → "MACRO 2", **TV** → "MACRO 3"
- The remote control flashes once for each command output.
- The remote control will output OSD information to tell you the status of the macro (for 1090VR).
- Some devices take up to 1 second to power on. The macro function has an automatic delay after any power function output.
- Pressing a button other than **AUDIO**, **VIDEO**, or **TV** cancels the macro program mode.

When **VIDEO** is pressed

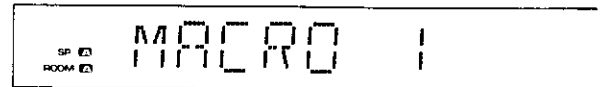

If you make connections to another room, you can use the remote control to select source components and to adjust the volume (etc.) output to the other room.

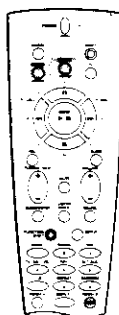

Keys or controls used in this operation.

Controlling the sound in another room (ROOM B) (for 1090VR)

1 Select a speaker system.

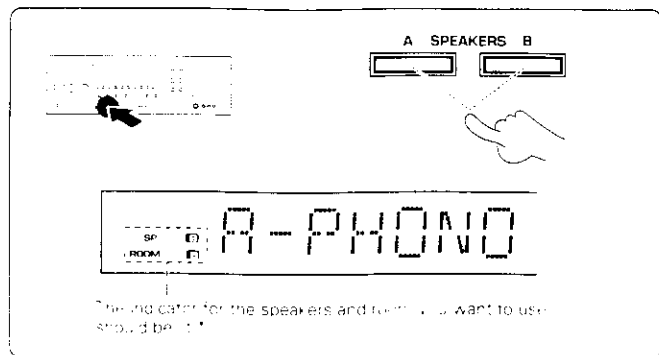

* Audio and video signals are output from the **SECOND ROOM PRE OUT** jacks regardless of the setting of the SP. A/B and ROOM A/B indicators.

A ON : Select to output sound to ROOM A from the speaker connected to the SPEAKERS A terminals. This setting allows you to enjoy surround playback in ROOM A while outputting sound to ROOM B via the SECOND ROOM PRE OUT jacks.

B ON : Select to output sound to ROOM B via the speakers connected to the SPEAKERS B terminals. Be sure to turn off the subwoofer in ROOM A if one is connected.

A+B ON : Select to output sound to ROOM A from the speakers connected to the SPEAKERS A terminals and output sound to ROOM B from the speakers connected to the SPEAKERS B terminals. ROOM A automatically switches to stereo playback (surround playback is not possible).

A+B OFF : No sound from the speakers. Use this setting when listening with headphones in ROOM A for stereo sound in all playback modes or to listen in ROOM B via the SECOND ROOM PRE OUT jacks.

2 Set the remote control to the ROOM B operation mode.

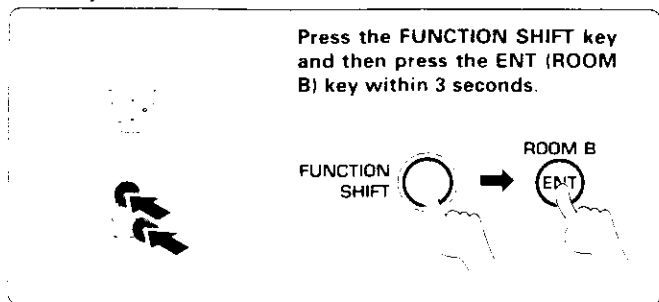

• The **MUTE** and **VOLUME +/-** keys let you control the sound level in ROOM B.

3 Select the desired component.

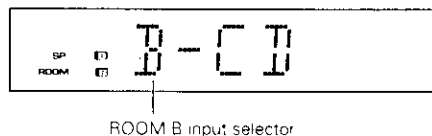
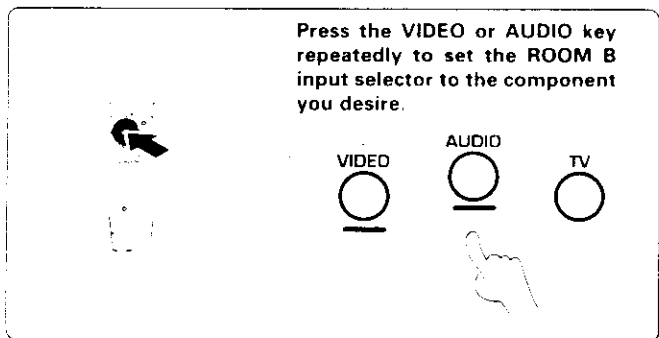

- The setting of the ROOM B input selector also appears in the on screen display (for 1090VR).
- The component selected for ROOM B can also be operated using the keys on the remote control. See "Remote operation of other components" for a list of keys available with each component.

4 Execute the desired operations.

The remote remains in the ROOM B operation mode until you switch back to the ROOM A operation mode.

To return to the ROOM A operation mode, press the **FUNCTION SHIFT** key and then press the **+10 (ROOM A)** key within 3

14

FutureSet allows you to update the remote control so it can operate new components which do not appear in the setup code list at the end of the manual.

This function allows you to register new setup codes for any or all of the following command positions: VIDEO1, VIDEO2, VIDEO3, VIDEO4, TV1, TV2, CABLE, CD, TAPE1/MD.

FutureSet codes are stored in memory. Each time a FutureSet upgrade is performed, any previous information in the FutureSet memory location is erased. Please inform your customer service representative if FutureSet has been previously used.

FutureSet upgrade option

- 1** Write down the brand name and model number of your component in the space provided before you call.
- 2** Call our Free-Phone Consumer Help-Line and explain which components you would like to add to your remote control.

USA: 1-800-753-9860

Canada: 1-800-644-0673

* This number is designed specifically for FutureSet upgrades. Questions about system operation should be first addressed to your place of purchase.

- 3** Hold down the ENT key until the backlight flashes twice.

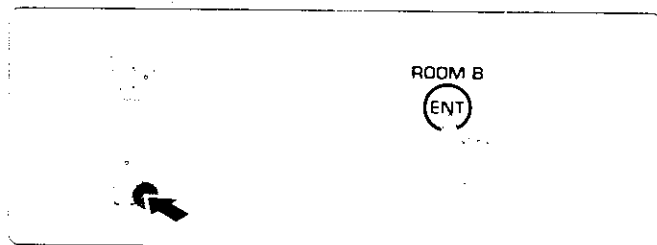

- 4** Enter the 3 digit code "997".

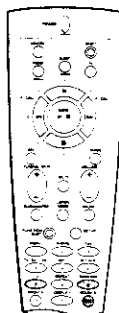
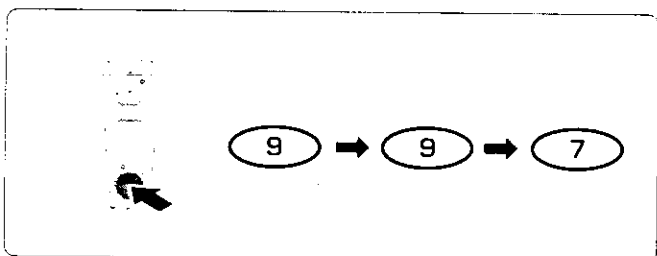

Keys or controls used in this operation.

	Type	Brand	Model No.	Remote Model No.
	TV	KENWOOD	KV7-7777	RC-7777
1				
2				
3				

- After our customer service representative records the brand name and model number of your component, he/she will ask you to hold the remote to the speaker portion of your telephone as shown below. Your remote control is KENWOOD model number: RC-R0905
- The hours for customer service in USA and Canada currently are:
 - Monday-Thursday 9:00 am - 7:00 pm EST
 - Friday 9:00 am - 5:30 pm EST
 - Saturday 12:00 pm - 4:00 pm EST

Complete steps 3 and 4 before holding the remote to the speaker portion of your telephone.

- At this time all inputs become available regardless of any earlier registration.



Go to step 4 within 5 seconds.

- The backlight flashes twice.
- The remote is now in the upgrade mode. The remote will wait for 30 seconds for a valid telephone download signal. If nothing is received within this time, it will revert to normal operation.



Go to step 5 within 30 seconds.

5 Hold your remote to the speaker portion of your telephone.

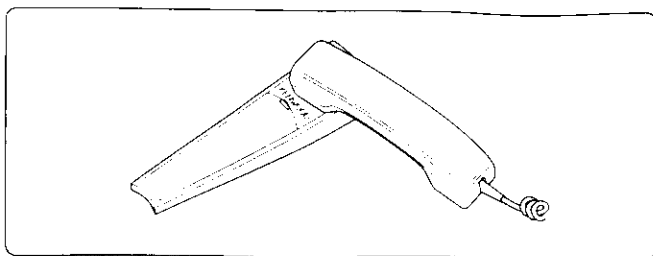

- For each setup code the operator can supply a setup code number. Should you ever need to change your input configuration, this number can be used. Please record for your future reference. If for some reason this information is lost, see "Checking a setup code" in the "Setup code correlation" section for further information.

Code selection after mode download

After successful completion of the download, step 5 above, the remote control automatically enters a special set-up mode which works as described below.

1 Select the component for which you want to register the information downloaded above.

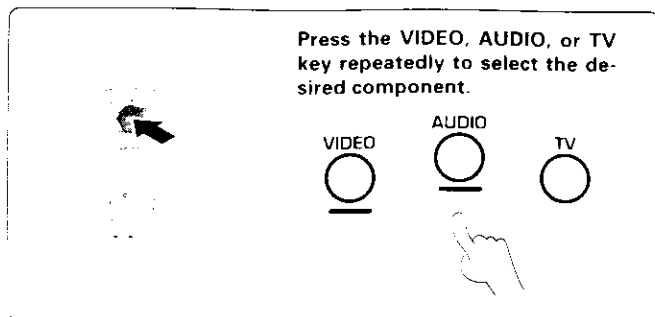

VIDEO key

- 1 VIDEO1 (VCR 1)
- 2 VIDEO2 (VCR 2)
- 3 VIDEO3 (LD)
- 4 VIDEO4 (DVD)

AUDIO key

- 1 CD (CD)
- 2 TAPE1/MD (TAPE)
- 3 PHONO

TV key

- 1 TV1
- 2 TV2
- 3 CABLE

- Example 1 : To register a code at the component connected to the VIDEO 1 jacks, select "VIDEO 1 (VCR)".



Perform each of the following steps within 5 seconds.

2 Press a numeric key.

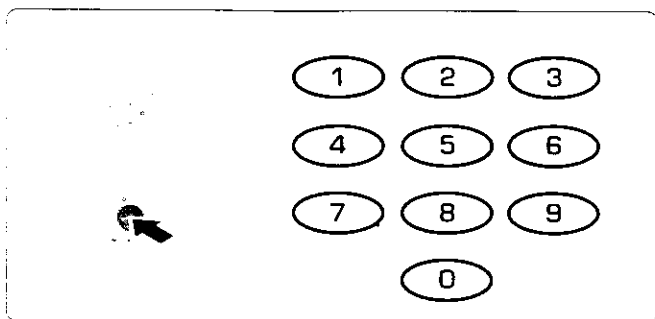

- Press the 1 key to output the POWER code of the first component on your list in step 1 of the previous page. Continue to push buttons 2 through 9 (and 0) until the component you want to register turns on.
- Though the FutureSet memory in your remote control is quite large, only 10 setup POWER codes can be put on the 10 keypad at any one time. If you require a larger download, the standard setup procedure can be used. See "Registering setup codes for other components", your customer service representative can supply you with the downloaded setup code numbers.

3 Repeat steps 1 and 2 to register all of the downloaded information.

4 Hold down the ENT key until the backlight flashes twice.

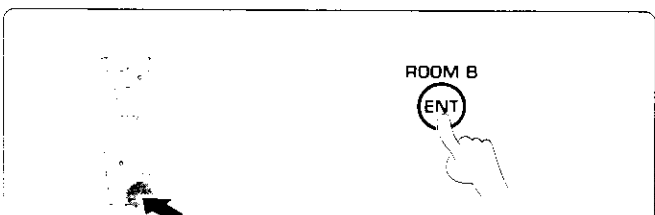

- The setup code for the last POWER code to be sent in step 2 is automatically registered at the location selected in step 1.

- At this time, the remote exits the special set-up mode and returns to its normal operation mode.

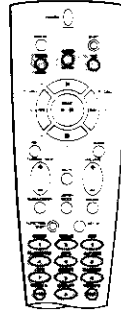

Keys or controls used in this operation.

Setup code correlation

Deleting a setup code

- ❶ Hold down the ENT key until the backlight flashes twice.
- ❷ Select the component to be deleted.
Press the VIDEO, AUDIO, or TV key repeatedly to select the desired component.
- ❸ Enter the 3 digit code "991".
- ❹ Hold down the ENT key until the backlight flashes twice.

- At this time all inputs become available regardless of any earlier registration.
- Example 1: To delete the registration of the component connected to the VIDEO 1 jacks, select "VIDEO 1".



Perform each step within 5 seconds.

- To resume the factory settings, proceed step 1, then enter "981".

Checking a setup code

- ❶ Hold down the ENT key until the backlight flashes twice.
- ❷ Select the component with setup code you want to check.
Press the VIDEO, AUDIO, or TV key repeatedly to select the desired component.
- ❸ Enter the 3 digit code "990".
- ❹ Press the 1 key and count the number of times the backlight blinks. This is the first number of the 4 digit setup code.
- ❺ Press the 2 key and count the number of times the backlight blinks. This is the second number of the 4 digit setup code.
- ❻ Press the 3 key and count the number of times the backlight blinks. This is the third number of the 4 digit setup code.
- ❼ Press the 4 key and count the number of times the backlight blinks. This is the fourth number of the 4 digit setup code.

- The backlight flashes twice immediately after the "0" is input to confirm input.
- If the backlight does not blink, the first digit in the setup code is 0.
- If the backlight does not blink, the second digit in the setup code is 0.
- If the backlight does not blink, the third digit in the setup code is 0.
- If the backlight does not blink, the fourth digit in the setup code is 0.



Perform each step within 5 seconds.

Non-IR codes

CD player	8900
Cassette deck	7900
LD player	5900
Phono	0900

Satellite	2900
TV	1900
VCR	4900

DVD	6900
DSS	3900
MD	8900

VCR Set up codes

Maker	Set up codes
Action	4317
Adventura	4000
Aiko	4278
Aiwa	4000, 4307, 4406
Akar	4041, 4315
Akiba	4072
Alba	4278, 4295
American High	4035
Amstrad	4000
Anani	4162, 4240
Anani National	4162, 4454
Anitech	4072
ASA	4037, 4081
Asha	4240
Asuka	4037
Audovox	4037
Bara	4000, 4041, 4104
Basic Line	4072, 4278
Beaumar	4240
Be & Howe	4104
Beaumar	4034, 4162
Brand Electronic	4041
Brooks	4121, 4184, 4211, 4295, 4361
Bush	4072, 4278
Car	4037
Canon	4035
Carver	4081
CCE	4072, 4278
CGE	4000
Comline	4072
Citizen	4037, 4278
Colt	4072
Craig	4037, 4047, 4072, 4240
Crown	4072, 4278
Curtis Mathes	4035, 4041, 4060
Cybernex	4240
Daewoo	4045, 4046, 4278
Dansat	4072

Maker	Set up codes
De Graaf	4042
Decca	4000, 4081
Dual	4041
Dumont	4000, 4081, 4104
Dynatech	4000
Elcotech	4072
Electrohome	4037
Electroponic	4037
Emerex	4032
Emerson	4000, 4002, 4037, 4043, 4121, 4184, 4211, 4278, 4295, 4361
ESC	4240, 4278
Ferguson	4041
Fidelity	4000
Finlandia	4081, 4104
Finlux	4000, 4042, 4081, 4104
Firstline	4037, 4043, 4045, 4072
Fisher	4046, 4047, 4066, 4104
Fuji	4033, 4035
Fujitsu	4000
Funai	4000
Garrard	4000
GE	4035, 4060
GEC	4081
Go Video	4232, 4350
GoldHand	4072
Goldstar	4037, 4038
Goodmans	4000, 4037, 4072, 4278
Gradiente	4000
Graetz	4041, 4104, 4240
Granada	4046, 4081, 4104
Grandin	4000, 4037, 4072
Grundig	4034, 4072, 4081
Hanseatic	4037
Harley Davidson	4000

Maker	Set up codes
Harmon/Kardon	4038
Harwood	4072
HCM	4072
Headquarter	4046
HI-Q	4047
Hinari	4072, 4240
Hitachi	4000, 4041, 4042, 4240
Hypson	4072
Imperial	4000
Interfunk	4081
ITT	4041, 4046, 4104, 4240
ITV	4037, 4278
Jensen	4041
JVC	4008, 4041, 4067
Kaisui	4072
KEC	4037, 4278
Kenwood	4038, 4041, 4067
KLH	4072
Kodack	4035, 4037
Korpel	4072
Lenco	4278
Leyco	4072
Lloyd	4000
Loewe	4037, 4081
Logik	4072, 4240
Luxor	4043, 4046, 4048, 4104
LXI	4037
M Electronic	4000
Magnavox	4035, 4039, 4081, 4149
Magnin	4240
Manesth	4045, 4072
Marantz	4035, 4081, 4295
Marta	4037
Matsui	4295
Matsushita	4035, 4162, 4454
MEI	4035

18 VCR Set up codes (continued)

Maker	Set up codes
Memorex	4000, 4035, 4037, 4039, 4046, 4047, 4048, 4104, 4240, 4307
Memphis	4072
Metz	4162, 4454
MGA	4043
MGN Technology	4240
Minolta	4042
Mitsubishi	4043, 4067, 4081, 4173
Motorola	4035, 4048
MTC	4000, 4240
Multitech	4000, 4072
Murphy	4000
NAD	4104
NEC	4038, 4041, 4067, 4104
Neckermann	4081
Nesco	4072
Nikko	4037
Nipon	4034
Noblex	4240
Nokia	4041, 4046, 4048, 4104, 4240
Nordmende	4041
Oceanic	4000, 4041
Orion	4315
Olympus	4035
Optimus	4037, 4048, 4104, 4162, 4454
Orion	4121, 4295
Osaka	4000, 4037, 4072
Ottocorona	4081
Palatone	4037, 4041, 4072
Palatone	4035, 4077, 4162, 4454
Pathe Marconi	4041
Penny	4035, 4037, 4038, 4042, 4240
Penta	4042
Perdio	4000
Phaco	4035, 4038
Philips	4035, 4081
Phonola	4081
Pilot	4037

Maker	Set up codes
Pioneer	4067, 4081
Profitronic	4240
Proline	4000
Protec	4072
Pulsar	4039
Pye	4081
Quarter	4046
Quartz	4046
Quasar	4035, 4077, 4162, 4454
Quelle	4081
Radio Shack	4000, 4037
Radiola	4081
Radix	4037
Randex	4037
RCA	4042, 4060, 4077, 4149, 4225
Realistic	4000, 4035, 4037, 4046, 4047, 4048, 4066, 4104, 4240
Rex	4041
Ricoh	4034
Roadstar	4037, 4072, 4240, 4278
Runco	4039
Saba	4041
Salora	4043, 4046
Samsung	4045, 4240
Sanky	4039, 4048
Sansui	4041, 4067
Sanyo	4046, 4047, 4104, 4240
SBR	4081
Schaub Lorentz	4000, 4041, 4104
Schneider	4000, 4072, 4081
Scott	4043, 4045, 4121, 4184, 4211
Sears	4035, 4037, 4042, 4046, 4047, 4066, 4104
SEG	4240
SEI	4081
Seico	4041
Sharp	4048
Shintom	4072, 4104
Shogun	4240
Siemens	4037, 4081, 4104

Maker	Set up codes
Silva	4037
Singer	4045, 4072
Sinudyne	4081
Sontec	4037
Sony	4032, 4033, 4034, 4035
STS	4042
Sunstar	4000
Suntronic	4000
Sylvania	4000, 4035, 4043, 4081
Symphonic	4000
Tandy	4000, 4104
Tashiko	4000
Tatung	4000, 4041, 4081
Teac	4000, 4041
Technics	4035, 4162
Teknika	4000, 4035, 4037
Teleavia	4041
Telefunken	4041
Tenosal	4072
Tensai	4000
Thomson	4041
Thorn	4041, 4104
TMK	4240
Toshiba	4041, 4043, 4045, 4060, 4066, 4081
Totevision	4037, 4240
Uher	4240
Unitech	4240
Universum	4000, 4037, 4081, 4240
Vector	4045
Vector Research	4038
Victor	4008, 4041, 4067
Video Concepts	4045
Videosonic	4240
Wards	4000, 4035, 4042, 4047, 4048, 4060, 4072, 4149, 4240
XR-1000	4000, 4035, 4072
Yamaha	4038
Yamishi	4072
Yokan	4072
Yoko	4240
Zenith	4033, 4034, 4039

TV Set up codes

Maker	Set up codes
Admiral	1093
Adventura	1046
Aiko	1092
Akai	1030
Alleron	1179
Ambassador	1177
Amstrad	1177
Anam	1180
Anam National	1055, 1250
AOC	1019, 1030, 1137
Audiovox	1180
Belcor	1019
Bel & Howell	1016, 1154
Blue Star	1282
BPL	1282
Bradford	1180
Brockwood	1019
Bush	1282
Candle	1030, 1046, 1056, 1186
Carnivale	1030
Carver	1054
Celebrity	1000
Citizen	1030, 1039, 1046, 1056, 1060, 1092, 1186, 1280
Concerto	1056
Conte	1180
Craig	1180
Crystall	1039, 1180
Curtis Mathes	1030, 1039, 1060, 1154
CNL	1180
Dana	1019, 1039, 1092, 1154, 1157
Davinci	1019
Dunham	1017, 1019
Electroband	1000
Electrohome	1381
Emerson	1019, 1039, 1154, 1177, 1178, 1179, 1180, 1236, 1280, 1282, 1463
Envisior	1030
Finnix	1179
Fisher	1154, 1159
Fortress	1093
Fujitsu	1179
Funa	1179, 1180
Futuretech	1180

Maker	Set up codes
GE	1021, 1027, 1047, 1051, 1055, 1135, 1178, 1282, 1451
General	1186
Gibraltar	1017, 1019, 1030
Goldstar	1019, 1030, 1039, 1056, 1178
Goodmans	1179
Grandin	1282
Grunpy	1179, 1180
Hallmark	1178
Harvard	1180
HCM	1282
Hinar	1179
Hisawa	1282
Hitachi	1056, 1145, 1151
Hypson	1282
Infinity	1054
Janeil	1046
JBL	1054
JCB	1000
JVC	1053
Kaisu	1282
KEC	1180
Kenwood	1019, 1030
Kloss	1024, 1046
KTV	1030, 1039, 1180, 1280
Logik	1016
Luxman	1056
LXI	1047, 1054, 1154, 1156, 1178
Magnavox	1024, 1030, 1054, 1186, 1187
Majestic	1016
Marantz	1030, 1054
Matsu	1177
Matsushita	1250
Megatron	1145, 1178
Memorex	1016, 1056, 1150, 1154, 1178
MGA	1019, 1030, 1150, 1178
Midland	1017, 1039, 1047, 1051, 1135
Minutz	1021
Mitsubishi	1019, 1150, 1178
Motorola	1055, 1093
MTC	1019, 1030, 1056, 1060
Multitech	1180
NAD	1156, 1166, 1178

Maker	Set up codes
NEC	1019, 1030, 1056
Nesco	1179
Nikko	1030, 1092, 1178
Noshi	1018
NTC	1092
Onwa	1180
Optimus	1154, 1166, 1250
Optonica	1093, 1165
Orion	1177, 1236
Panasonic	1051, 1055, 1250
Penny	1018, 1019, 1021, 1027, 1030, 1039, 1047, 1051, 1060, 1135, 1156, 1178
Philco	1019, 1030, 1054
Philips	1054
Pilot	1019, 1030, 1039
Pioneer	1166
Portland	1019, 1039, 1092
Prism	1051
Proscan	1047
Proton	1031, 1178, 1466
Pulsar	1017, 1019
Quasar	1051, 1055, 1165, 1250
Radio Shack	1019, 1030, 1039, 1047, 1056, 1154, 1165, 1178, 1180
RCA	1018, 1019, 1047, 1090, 1135
Realistic	1019, 1030, 1039, 1056, 1154, 1165, 1178, 1180
Runco	1017, 1030
Saisho	1177
Sampo	1030, 1039
Samsung	1019, 1030, 1039, 1056, 1060, 1178, 1427
Samsux	1039
Sanyo	1154, 1159
Scimitsu	1019
Scotch	1178
Scott	1019, 1178, 1179, 1180, 1236
Sears	1047, 1054, 1056, 1154, 1156, 1159, 1178, 1179
SEI	1177
Sharp	1039, 1093, 1165
Shogun	1019
Signature	1016
Simpson	1186, 1187

20 TV Set up codes (continued)

Maker	Set up codes
Sinudyne	1177
Sony	1000
Soundesign	1178, 1179, 1180, 1186
Spectricon	1137
SSS	1019, 1180
Starlite	1180
Supra	1056
Supre-Macy	1046
Supreme	1000
Sylvania	1030, 1054, 1381
Tandy	1039, 1093

Maker	Set up codes
Tatung	1055
Technics	1051, 1250
Technol Ace	1179
Techwood	1051, 1056
Teknika	1016, 1019, 1039, 1054, 1056, 1060, 1092, 1150, 1179, 1180, 1186, 1312
Tera	1031
TMK	1056, 1177, 1178
Tomashi	1282
Toshiba	1060, 1154, 1156
Totevision	1039

Maker	Set up codes
Triumph	1177
Universal	1027
Vector Research	1030
Victor	1053, 1250
Vidikron	1054
Vidtech	1019, 1178
Viking	1046, 1312
Wards	1016, 1019, 1021, 1027, 1030, 1054, 1056, 1165, 1178, 1179
Yamaha	1019, 1030
Zenith	1016, 1017

Satellite Set up codes

Maker	Set up codes
Echostar	2280
General Instrument	2361

Maker	Set up codes
Jerrold	2361
Primestar	2361

Maker	Set up codes
Realistic	2052
Uniden	2052

LD player Set up codes

Maker	Set up codes
Carver	5194
Disco Vision	5023
Hitachi	5023
Kenwood	5258
Magnavox	5194
Marantz	5194

Maker	Set up codes
Mitsubishi	5059
NAD	5059
Panasonic	5204
Philips	5194
Pioneer	5023, 5059

Maker	Set up codes
Quasar	5204
Sega	5023
Sony	5201
Telefunken	5059
Theta Digital	5194

DSS Set up codes

Maker	Set up codes
Alphastar	3772
Echostar	3775
HTS	3775
Hughes Network Systems	3749

Maker	Set up codes
Jerrold	3627
Panasonic	3701
Primestar	3627

Maker	Set up codes
RCA	3566
Sony	3639
Toshiba	3790

DVD Set up codes

Maker	Set up codes
Panasonic	6490
Toshiba	6503

Cable Set up codes

Maker	Set up codes
ABC	0001, 0003, 0007, 0008, 0011, 0013, 0014, 0017
Antronix	0022
Archer	0022, 0153, 0797
Belcor	0056
Cable Star	0056
Cabletenna	0022
Cableview	0022
Century	0153
Citizen	0153
Colour Voice	0025
Comtronics	0040
Contec	0019
Daeryung	0008
Eastern	0002
Everquest	0015, 0040
Garrard	0153
GC Electronics	0056
Gemin	0015
General Instrument	0011, 0276, 0476
GoldStar	0040, 0144
Hamlin	0009, 0020, 0034, 0259

Maker	Set up codes
Hitachi	0011
Hytex	0007
Jasco	0153
Jerrold	0003, 0011, 0012, 0014, 0015, 0276, 0476
Memorex	0000
Movie Time	0063, 0156
NSC	0063, 0156
Oak	0007, 0019
Panasonic	0000, 0021, 0107
Paragon	0000
Philips	0025, 0153
Pioneer	0144, 0753
Prelude	0770
Pulsar	0000
PVP Stereo Visual Matrix	0003
Radio Shack	0797
RCA	0021
Regal	0020, 0259
Regency	0002
Rembrandt	0011
Runco	0000
Samsung	0040, 0144

Maker	Set up codes
Scientific Atlanta	0008, 0017, 0477
Signal	0015, 0040
Signature	0011
SL Marx	0040
Sprucer	0021
Starcom	0003, 0015
Stargate	0015, 0040, 0770
Starquest	0015
STS	0156
Sylvania	0001
Tandy	0258
Televue	0040
Texscan	0001
Tocom	0012, 0013
Toshiba	0000
Tusa	0015
TV86	0063
Unika	0022, 0153
United Artists	0007
United Cable	0003
Universal	0022, 0056, 0153
Viewstar	0063, 0258
Zenith	0000, 0525

CD Player Set up codes

Maker	Set up codes
Alfa	8124, 8157
Arcan	8157
AudioTor	8157
California Audio Lab	8029
Carver	8157, 8179
Cyber	8157
Denon	8003
DKK	8000
Dynamic Bass	8179
Elektra	8393
Emerson	8305
Fisher	8048, 8088, 8179
Garrard	8393
Genexxa	8032, 8305
Goodmans	8305
Grundig	8157
Hitachi	8032
JVC	8072, 8655
Kenwood	8028, 8037, 8048, 8099, 8190, 8858, 8859

Maker	Set up codes
Krell	8157
Linn	8157
LXI	8305
Magnavox	8157
Marantz	8029, 8157
Matsui	8157
MCS	8029
Memorex	8032, 8305
Meridian	8157
Micromega	8157
Mission	8157
NAD	8000
Naim	8157
NSM	8157
Onkyo	8101
Optimus	8000, 8032, 8037, 8179, 8305, 8468
Panasonic	8029, 8303
Philips	8157
Pioneer	8032, 8305, 8468
Proton	8157

Maker	Set up codes
QED	8157
Quad	8157
Quasar	8029
RCA	8053, 8179, 8305
Realistic	8179
Revox	8157
Rotel	8157
SAE	8157
Sansui	8157, 8305
Sanyo	8179
Scott	8305
Sears	8305
Sharp	8037
Sony	8000, 8185, 8604, 8605
Soundesign	8145
Tandy	8032
Teac	8393
Technics	8029, 8303
Univsum	8157
Victor	8072
Yamaha	8036, 8187

22 DAT deck Set up codes

Maker	Set up codes
Carver	7158
Denon	7031
Grundig	7158

Maker	Set up codes
Marantz	7158
Philips	7158

Maker	Set up codes
Sony	7093
Technics	7158

Cassette deck Set up codes

Maker	Set up codes
Aiwa	7029, 7197
Arcam	7076
Carver	7029
Denon	7076
Fisner	7074
Garrard	7308, 7309
Grundig	7029
Inke	7071

Maker	Set up codes
JVC	7244, 7273, 7274
Kenwood	7000, 7071, 7183
Magnavox	7029
Marantz	7009, 7029
Onkyo	7136
Optimus	7027, 7220
Panasonic	7229
Philips	7029
Pioneer	7027, 7220

Maker	Set up codes
Revox	7029
Sansui	7009, 7029
Sony	7170, 7243, 7291
Teac	7308, 7309
Technics	7229
Victor	7244, 7273, 7274
Wards	7027
Yamaha	7094, 7097

MD Set up codes

Maker	Set up codes
Kenwood	9000, 9826
Sony	9490

Misc. audio Set up codes

Maker	Set up codes
Grundig	8459, 8526

Maker	Set up codes
Scientific Atlanta	8460

Maker	Set up codes
Starcom	8459

Symptom	Cause	Remedy
The backlight flashes five times during normal operation.	<ul style="list-style-type: none"> The batteries are nearing exhaustion. 	<ul style="list-style-type: none"> Replace with new batteries to preserve the currently registered setup information. → 5.
Certain inputs cannot be selected using the remote control.	<ul style="list-style-type: none"> No preset codes registered at for the respective input(s). 	<ul style="list-style-type: none"> Register a preset code or Non-IR code at the respective input(s). → 6.
Remote control operation is not possible.	<ul style="list-style-type: none"> The remote control is set to a different operation mode. Batteries are exhausted. The remote control unit is too far away from the main system, controlling angle is too large, or there is an obstacle between the receiver and the remote. The audio cords and system control cords are not connected properly No software is loaded in the source component An attempt is made to play a tape which is being recorded in the cassette deck. The remote control has not been set to the operation mode for the component you wish to control. The remote control is in the Room B (A) operation mode. The microprocessor of the remote control malfunctions 	<ul style="list-style-type: none"> Press VIDEO, AUDIO, or TV to select the appropriate operation mode. Replace with new batteries. If the backup is exhausted before you can replace the batteries, redo the setup procedure. → 5, → 6. Operate the remote control unit within the controllable range. Connect properly. Place software in the source component you want to play. Wait until recording has completed. Press the VIDEO, AUDIO, or TV key to activate the operation mode for the component you want to control before operation. → 9. Change the operation mode. → 13. Reset the microprocessor. → 16.



Do not use contact cleaning agents because they could cause a malfunction. Be specifically careful against using contact cleaning agents containing oil, since they may deform the plastic components

Specifications

Remote control system	Infrared
Transmitter power supply	6 V DC
Dimensions	W : 62 mm (2-7/16")
	H : 227 mm (8-15/16")
	D : 37 mm (1-7/16")
Weight (Excluding batteries)	170 g (0.4 lb)



KENWOOD follows a policy of continuous advancements in development. For this reason specifications may be changed without notice.

Remote operation of other components

Refer to the following for the type of remote control operations available for each component. The setup code for each component must be entered beforehand.

- 1 Use the AUDIO, VIDEO, or TV keys to select the component you want to control.
- 2 Press the keys corresponding to the operations you desire. Refer to the following sections for details.

- When pressing keys in succession, press each key firmly and be sure to wait at least 1 second before pressing the next key.
- Numeric keys function the same as the numeric keys on the original remote.
- To execute a FUNCTION SHIFT command, press the **FUNCTION SHIFT** key, then press the corresponding key within 3 seconds.



1. Although each setup code is designed to work with a number of different models, certain codes may not work with some models. (Also, certain codes may only operate some of the functions available on a given model.)
2. The charts below show the typical functions available for each component. Some manufacturers use different key combinations to perform similar functions. For that reason, we have programmed extra functions on some of the unused number keys to help you control your equipment. To find if your component has extra functions, press the **FUNCTION SHIFT** key, then press a number key. Repeat this procedure for each number key.

Tuner operations

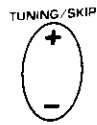

TUNING

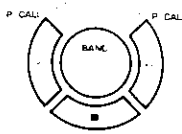

- ▶/|| (BAND)
- (AUTO)
- ◀◀ (P.CALL -)
- ▶▶ (P.CALL +)

ROOM B mode: P.CALL +/- only

FUNCTION SHIFT

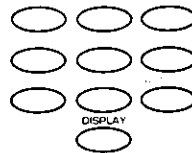

FUNCTION SHIFT commands
DISPLAY (Dimmer)

Cassette deck operations



- + (▶ Play)
- (◀ Play)

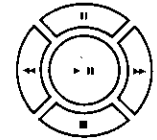

- ▶/|| (▶ Play)
- || (Pause)
- (Stop)
- ◀◀ (◀◀ Rewind)
- ▶▶ (▶▶ Fast forward)



(● Record)

CD player operations

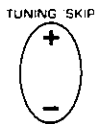

- + (Disc Skip +)
- (Disc Skip -)

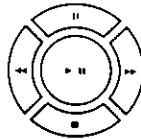

- ▶/|| (Play/Pause (for SL16))
- ▶/|| (▶ Play (for other))
- || (Pause (for other))
- (Stop)
- ◀◀ (Skip)
- ▶▶ (Skip)

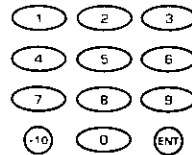

Numeric keys

FUNCTION SHIFT

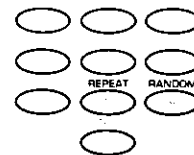

FUNCTION SHIFT commands
REPEAT (Repeat)
RANDOM (Random)
DISPLAY (Dimmer)

MD recorder operations



- + (▶▶ Search)
- (◀◀ Search)

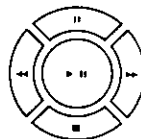

- ▶/|| (▶ Play)
- || (Pause)
- (Stop)
- ◀◀ (Skip back)
- ▶▶ (Skip forward)

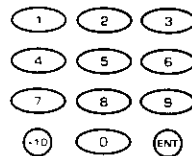

Numeric keys

FUNCTION SHIFT

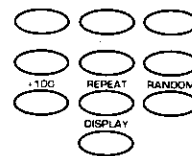

FUNCTION SHIFT commands
+100 (+100)
REPEAT (Repeat)
RANDOM (Random)
DISPLAY (Dimmer)

TV operations

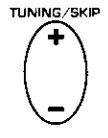

+ (Channel +)
- (Channel -)

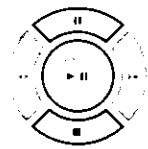

▶ || (Mute)
|| (Volume +)
■ (Volume -)

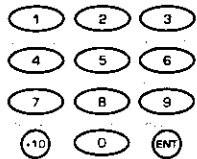

Numeric keys

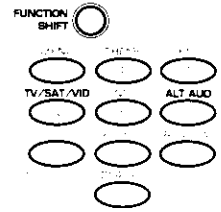

FUNCTION SHIFT commands
TV/SAT./VID (Input selector)
ALT AUDIO (Alternate audio)

VCR operations



+ (Channel +)
- (Channel -)

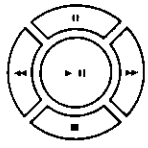

▶ || (▶ Play)
|| (Pause)
■ (Stop)
◀◀ (◀◀ Rewind)
▶▶ (▶▶ Fast forward)

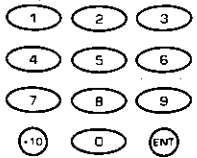

Numeric keys

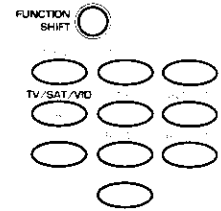

FUNCTION SHIFT commands
TV/SAT./VID (Input selector)

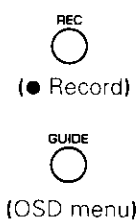

REC
(● Record)
GUIDE
(OSD menu)

LD player operations

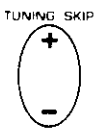

+ (▶ ◀ B)
- (B)

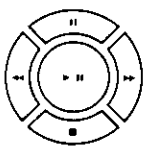

▶ || (▶ Play)
|| (Pause)
■ (Stop)
◀◀ (Skip back)
▶▶ (Skip forward)

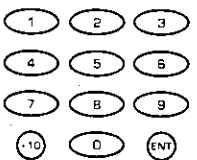

Numeric keys

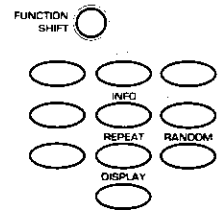

FUNCTION SHIFT commands
INFO (Frame-time)
REPEAT (Repeat)
RANDOM (Random)
DISPLAY (Display)



GUIDE
(OSD menu)

Satellite tuner operations

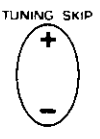

+ (Channel +)
- (Channel -)

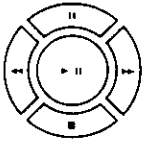

▶ || (Select)
|| (↑)
■ (↓)
◀◀ (←)
▶▶ (→)

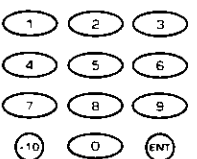

Numeric keys

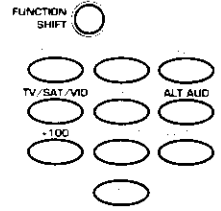

FUNCTION SHIFT commands
TV/SAT./VID (Input selector)
ALT AUDIO (Alternate audio)
+100 (+100)



GUIDE
(OSD menu)

DSS receiver operations



+ (Channel +)
- (Channel -)

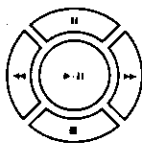

▶ II (Select)
II (↑)
■ (↓)
◀▶ (←)
▶▶ (→)

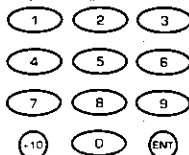

Numeric keys

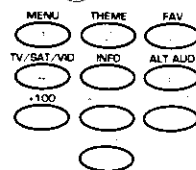

GUIDE

(CH Guide)

FUNCTION SHIFT commands

- MENU (Menu)
- THEME (Theme)
- FAV. (Favorite)
- TV/SAT./VID (Input selector)
- INFO (Information)
- ALT AUDIO (Alternate audio)
- +100 (+100)

Cable tuner operations

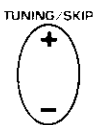

+ (Channel +)
- (Channel -)

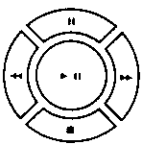

▶ II (Select)
II (↑)
■ (↓)
◀▶ (←)
▶▶ (→)

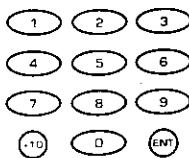

Numeric keys

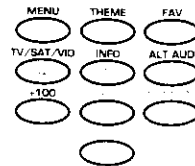

GUIDE

(OSD menu)

FUNCTION SHIFT commands

- MENU (Menu)
- THEME (Theme)
- FAV. (Favorite)
- TV/SAT./VID (Input selector)
- INFO (Page)
- ALT AUDIO (Alternate audio)
- +100 (+100)

DVD player operations

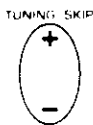

+ (Display +)
- (Display -)

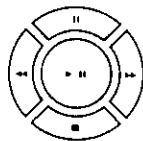

▶ II (▶ Play)
II (Pause)
■ (Stop)
◀▶ (Skip back)
▶▶ (Skip forward)

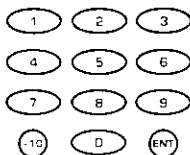

Numeric keys

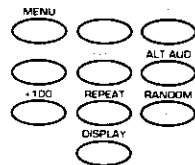

REC

(● Record)

GUIDE

(OSD menu)

FUNCTION SHIFT commands

- ALT AUDIO (Alternate audio)
- +100 (+100)
- REPEAT (Repeat)
- RANDOM (Random)
- DISPLAY (Display)

KENWOOD

For your records

Record the serial number, found on the back of the unit, in the spaces designated on the warranty card, and in the space provided below. Refer to the model and serial numbers whenever you call upon your dealer for information or service on this product.

Model _____ Serial Number _____

TV operations

TUNING/SKIP



+ (Channel +)
- (Channel -)

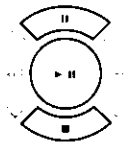

▶ II (Mute)
II (Volume +)
■ (Volume -)

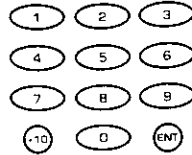

Numeric keys

FUNCTION SHIFT

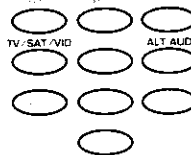

FUNCTION SHIFT commands
TV/SAT./VID (Input selector)
ALT AUDIO (Alternate audio)

VCR operations

TUNING/SKIP



+ (Channel +)
- (Channel -)

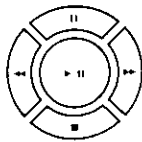

▶ II (▶ Play)
II (Pause)
■ (Stop)
◀▶ (◀◀ Rewind)
▶▶ (▶▶ Fast forward)

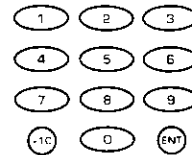

Numeric keys

FUNCTION SHIFT

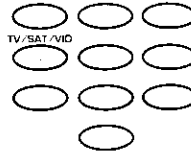

FUNCTION SHIFT commands
TV/SAT./VID (Input selector)

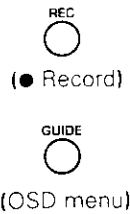

LD player operations

TUNING/SKIP



+ (▶▶▶ Play)
- (◀◀◀ Stop)

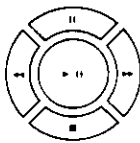

▶ II (▶▶▶ Play)
II (Pause)
■ (Stop)
◀▶ (◀◀◀ Stop back)
▶▶ (▶▶▶ Skip forward)

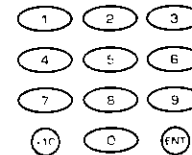

Numeric keys

FUNCTION SHIFT

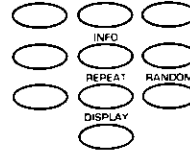

FUNCTION SHIFT commands
INFO (Frame-time)
REPEAT (Repeat)
RANDOM (Random)
DISPLAY (Display)



Satellite tuner operations

TUNING/SKIP



+ (Channel +)
- (Channel -)

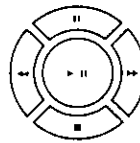

▶ II (Select)
II (↑)
■ (↓)
◀▶ (←)
▶▶ (→)

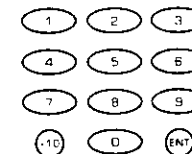

Numeric keys

FUNCTION SHIFT

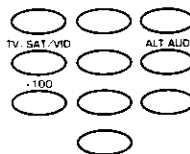

FUNCTION SHIFT commands
TV/SAT./VID (Input selector)
ALT AUDIO (Alternate audio)
+100 (+100)

